

**PLAN VIEW**

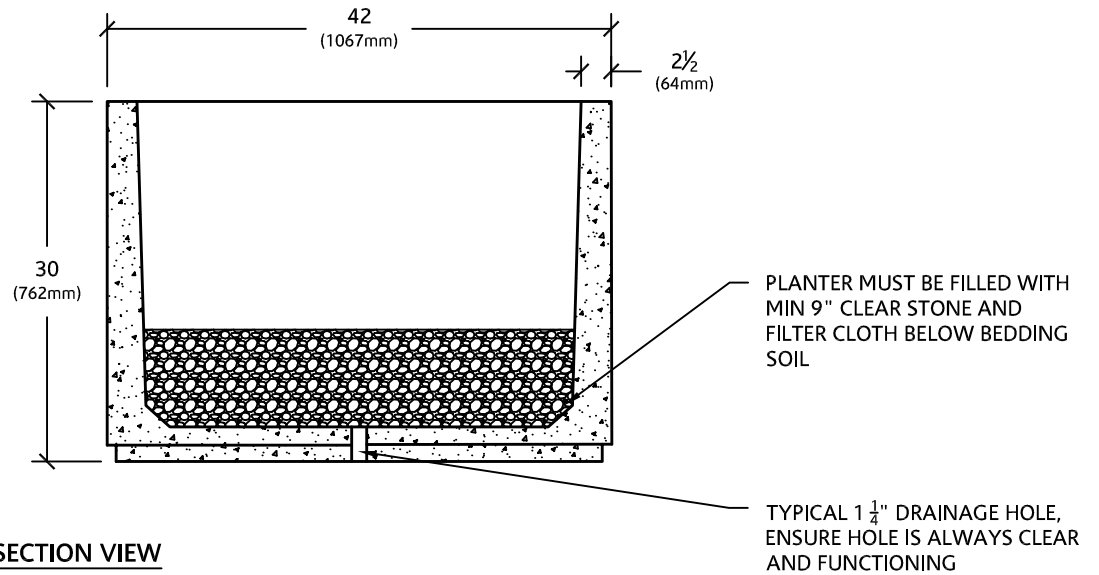

**SECTION VIEW**

**NOTES:**

1. CONTRACTOR TO REFER TO ARCHITECTURAL SPECIFICATIONS FOR COLOUR, FINISH AND VALUE ADDED FEATURES
2. SUBMIT COLOUR AND FINISH SAMPLES FOR APPROVAL
3. WEIGHT OF SQUARE SQ164230 PLANTER - 900 lbs



**SQUARE PLANTER**

**SQ164230**

ED'S CONCRETE PRODUCTS  
1266 ERIE STREET  
STRATFORD, ONTARIO  
N4Z 0A1

1-877-265-6590  
www.edskoncrete.com  
info@edskoncrete.com

